

Schema idraulico
 Hydraulic diagram

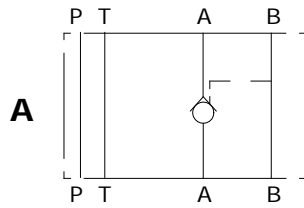

A

Lato Lamature/OR side

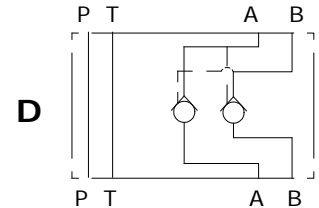

D

Lato Lamature/OR side

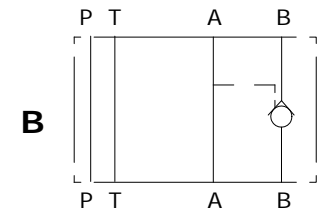

B

Lato Lamature/OR side

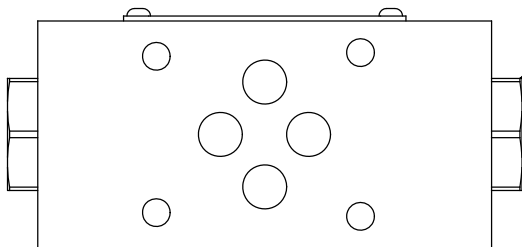

C007
 VRS-S08-01*

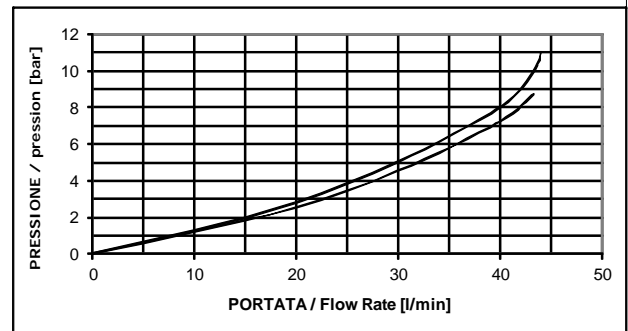
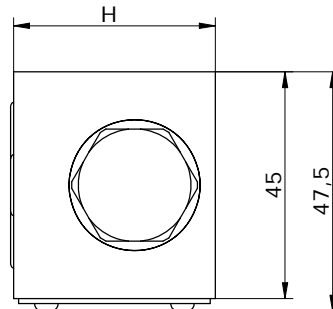
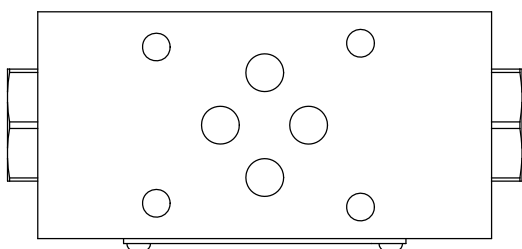
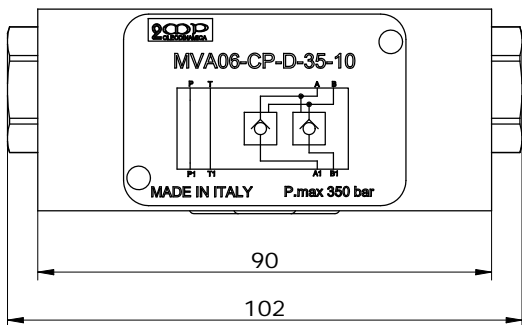

VERSION	H
MV_06 - CP - _ - 35	40
MV_06 - CP - _ - 95	45

MV_06 - CP - _ - _ - 10

S = STEEL
A = ALUMINUM

D = DOUBLE
A = PORT A
B = PORT B

SERIES

35 = 1:3.5 PILOT RATIO
95 = 1:9.5 PILOT RATIO

*see **CARTDRIGE VALVES** catalog