

Schema idraulico
Hydraulic diagram

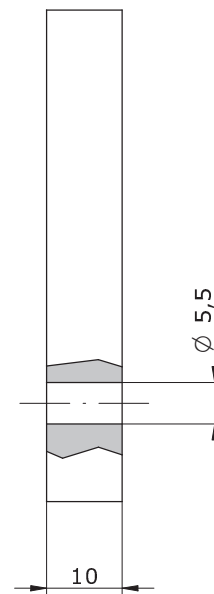
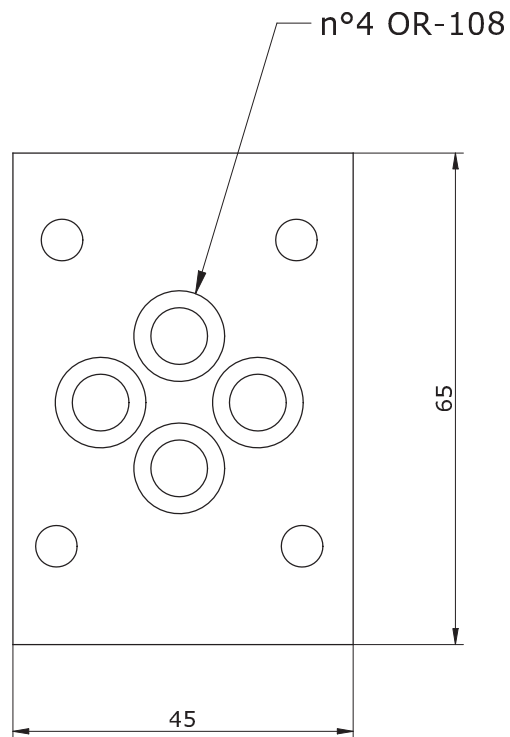
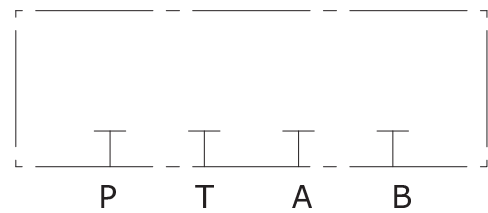

E_06 - 00 - 10

S = STEEL