

Schema idraulico
 Hydraulic diagram

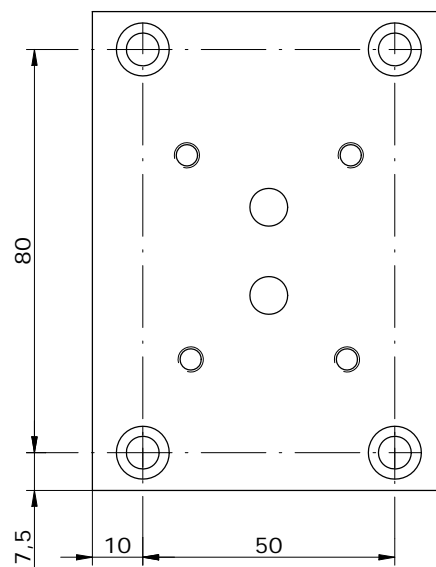
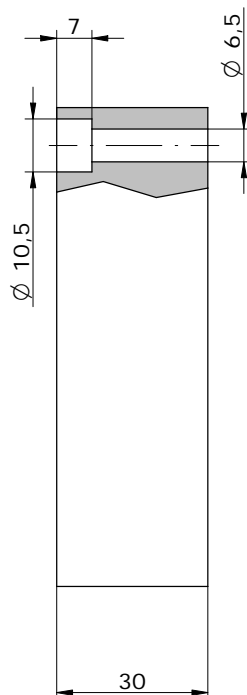
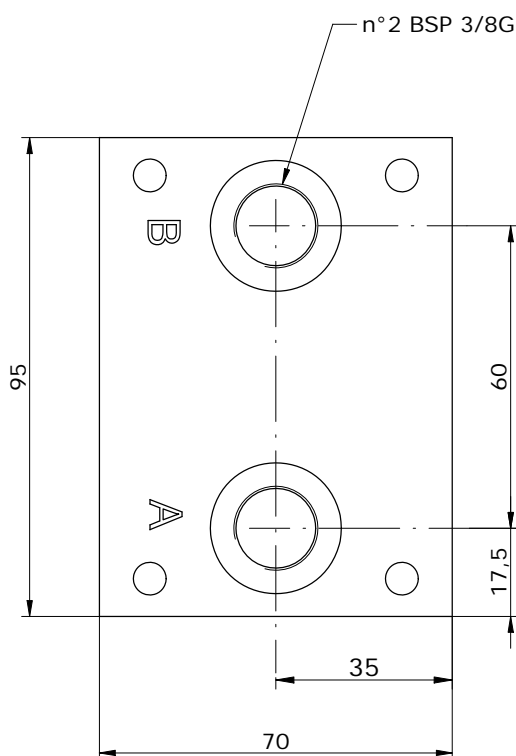
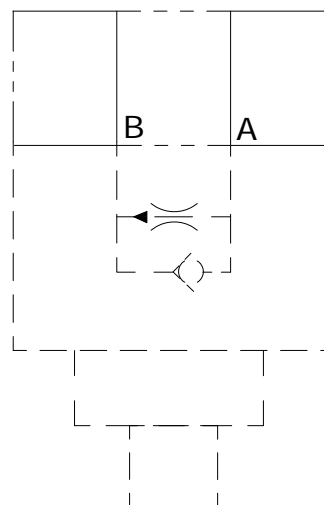

E_ 06 - 02 - 38

S = STEEL
A = ALUMINUM