

Schema idraulico
 Hydraulic diagram

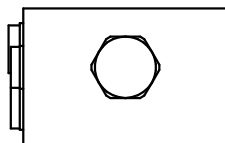
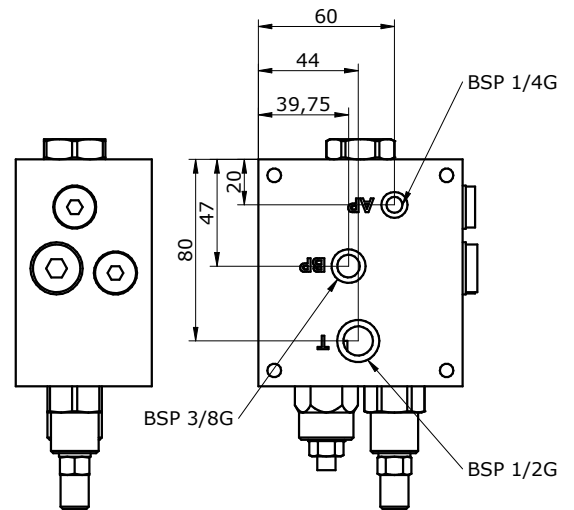
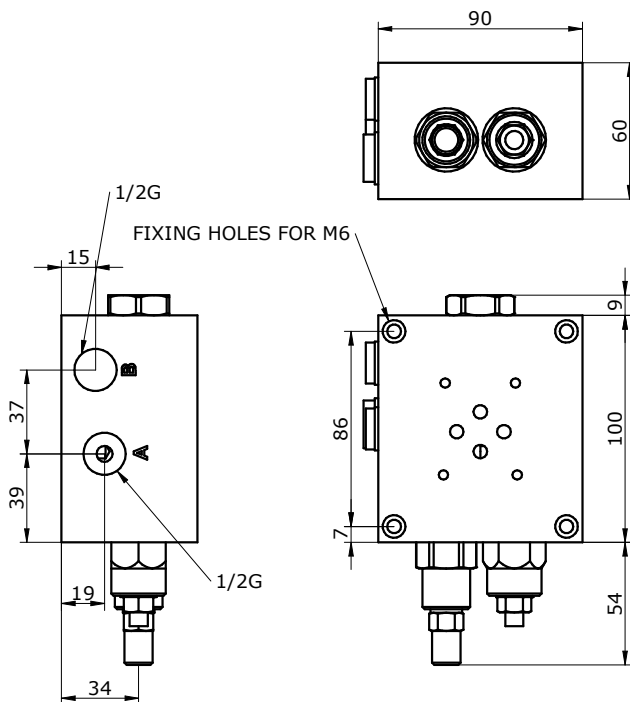
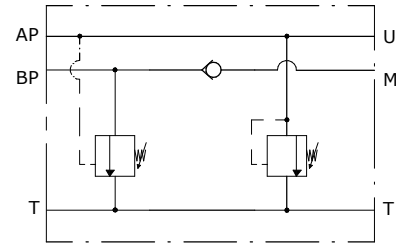
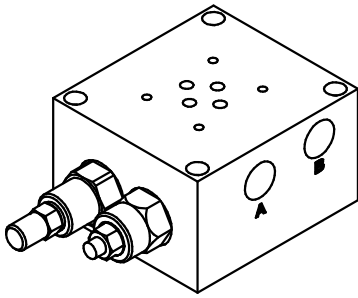

HLPE06 - - - - - 10

S = STEEL

LOW PRESSURE SETTINGS:
020=20-80 bar

HIGH PRESSURE SETTINGS:
050 =50-350 bar