

Schema idraulico
 Hydraulic diagram

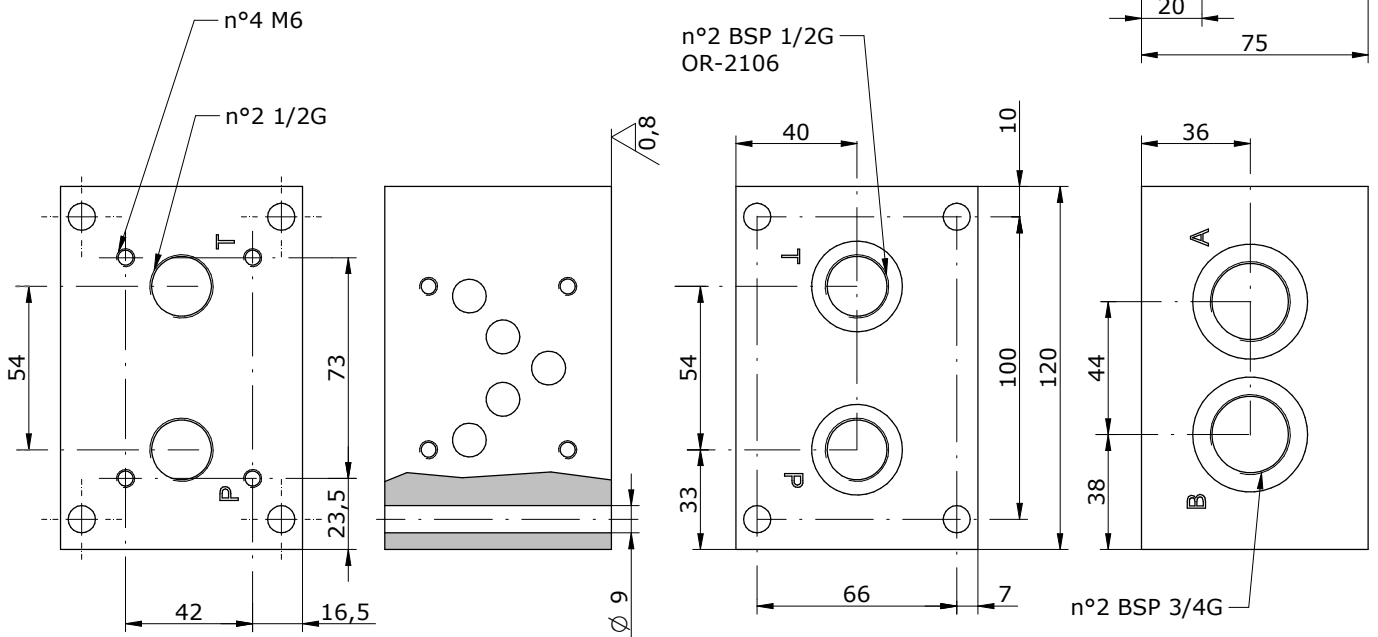
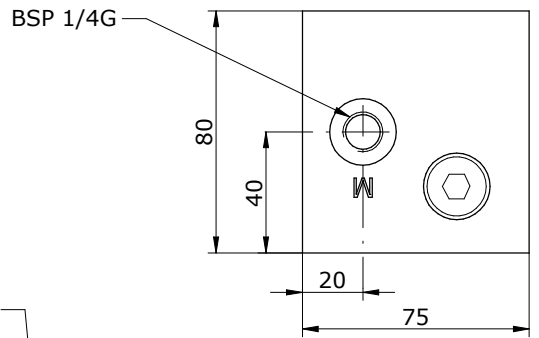
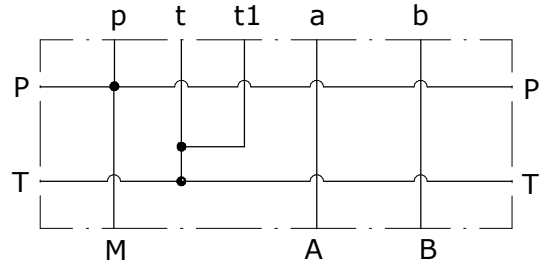

E_ 610 - 26 - 34

S = STEEL
A = ALUMINIUM