

Schema idraulico
Hydraulic diagram

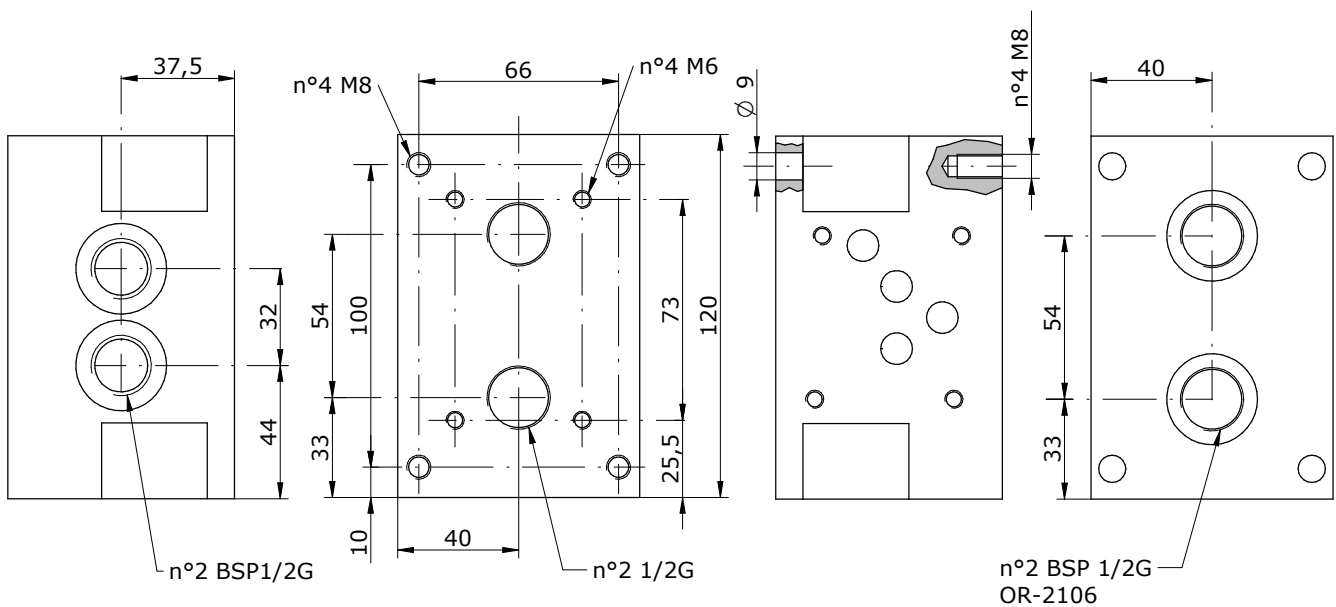
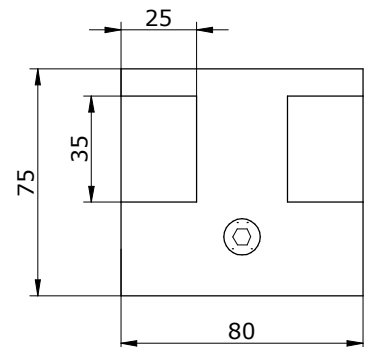
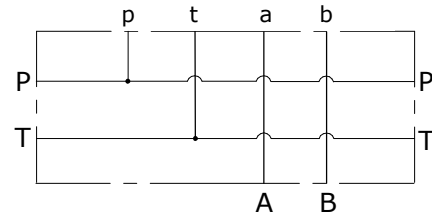
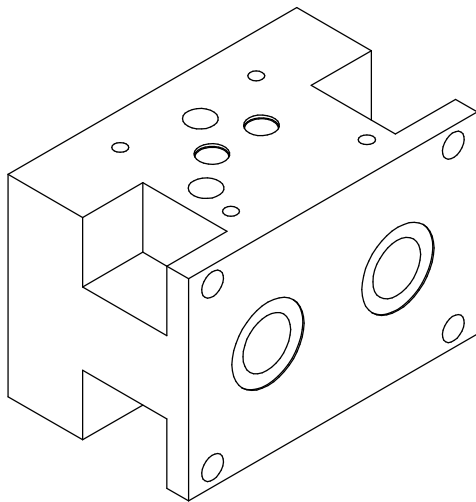

E_ 610 - 30 - 12

S = STEEL
A = ALUMINIUM